

POWER RELAY

1 POLE - 8A (65A High Inrush Current)

JS-KS Series

■ FEATURES

- Inrush current 65A, 1000W, lamp load
- UL class B (130°C) coil wire insulation
- 1 form A (SPST-NO)
- Low profile and space saving
Height: 12.5 mm - Mounting space: 290 mm²
- High sensitivity in small package
Operating power 84 to 110 mW
Nominal power 220 to 290 mW
- High insulation in small package
Insulation distance : 8.0 mm (between coil and contacts)
Dielectric strength : 5,000 VAC
Surge strength : 10,000 V
- Plastic materials
UL 94 flame class V-0
UL CTI level class 2
- Plastic sealed type, RTIII
- RoHS compliant
Please see page 6 for more information



■ Part Numbers

[Example] JS - 12 M N - K S
 (a) (b) (c) (d) (e) (f)

(a)	Relay type	JS : JS-KS series
(b)	Contact rated voltage	12 : 5....60VDC Coil rating table at page 3
(c)	Coil configuration	M : 1 form A (SPST-NO)
(d)	Contact material	N : Gold flash silver tin oxide
(e)	Enclosure	K : Plastic sealed type, RTIII
(f)	Construction	S : 5.0mm (lamp load 1000W, 230VAC, 25k operations)

Note: Actual marking omits the hyphen (-) or (*)

JS-KS Series

■ Specifications

Item			JS-()MN - KS	Remarks / conditions	
Contact data	Configuration		1 form A (SPST-NO)		
	Construction		Single		
	Material		AgSnO ₂ + Gold flash 0.1μm		
	Resistance		Max.100mΩ at 6VDC, 1A		
	Contact rating		8A, 250VAC / 24VDC	Resistive	
	Max. carrying current		10A		
	Max. inrush current		65A, 250VAC		
	Max. switching voltage		400VAC / 150VDC		
	Max. switching power		2000VA / 192W		
	Min. switching load *1		100 mA, 5VDC		
Coil	Rated power (20°C)		220 - 290mW		
	Operate power (20°C)		84 - 110mW		
	Operating temperature range		-40°C ~ +85°C (at rated voltage)	No frost	
Timing data	Operate		Max. 10ms	without bounce	
	Release		Max. 5ms	without bounce, no diode	
Life	Mechanical		Min. 20 x 10 ⁶ operations		
	Electrical (resistive)	AC contact rating	Min. 100 x 10 ³ operations	At rated load	
		DC contact rating	Min. 100 x 10 ³ operations	At rated load	
		Lamp load (TV-4)	1000W 25x10 ³ operations		
Insulation	Insulation resistance		Min. 1000MΩ at 500VDC		
	Dielectric strength	Open contacts	1000VAC (50/60Hz), 1 minute		
		Coil contact	5000VAC (50/60Hz), 1 minute		
	Surge strength	Coil to contacts	10000V / 1.2 x 50μs standard wave		
	Clearance		8mm		
	Creepage		8mm		
	EN61810-1, VDE0435	Voltage		250V	
		Pollution		3	
		Material group		III a	
Category		C / 250V (reference voltage) (VDE 01106)			
Other	Vibration resistance	Misoperation	10Hz ~ 55Hz ~ 10Hz single amplitude 0.825mm		
		Endurance	10Hz ~ 55Hz ~ 10Hz single amplitude 1.65mm		
	Shock resistance	Misoperation	Min. 100m/s ² (11 ± 1ms)		
		Endurance	Min. 1,000m/s ² (6 ± 1ms)		
	Dimensions / weight		10.0 x 29.0 x 12.5 mm / approx. 8.0g		
	Sealing		Plastic sealed		

*1: Minimum switching loads mentioned above are reference values. Please perform the confirmation test with actual load before production since reference values may vary according to switching frequencies, environmental conditions and expected reliability levels.

JS-KS Series

■ Coil Data

Coil code	Rated Coil Voltage (VDC)	Coil Resistance +/-10% (Ω)	Must Operate Voltage* (VDC)	Must Release Voltage* (VDC)	Rated Power (mW)
005	5	112	3.5	0.5	225
006	6	160	4.2	0.6	
009	9	360	6.3	0.9	
012	12	660	8.5	1.2	220
018	18	1,455	12.7	1.8	225
024	24	2,350	16.8	2.4	245
048	48	8,000	33.4	4.8	290
060	60	12,500	41.7	6.0	

Note: All values in the table are valid at 20°C and zero contact current, unless otherwise specified.

*: Specified operated values are valid for pulse wave voltage.

Note: Please use at rated coil voltage. Please refer to characteristic data and set up adequate voltage in case of use at over voltage.

Care shall be taken on the heat generated on PC board when maximum carrying current exceeds 10A. Please perform the confirmation test with actual conditions.

■ Safety Standards

Type	Compliance	Contact rating
UL	UL 508	Flammability: UL 94-V-0 (plastics) 10A, 30VDC (resistive) 10A, 250 VAC (resistive) TV-4, 120VAC/240VAC (N.O.) 1/4hp 125VAC/250VAC, 1/3hp 125vac, 1/2hp 250VAC Pilot duty: C150, A300, B300, R300
	File No. E 56140	
CSA	C22.2 No. 14 File No. LR 35579	

JS-KS Series

■ Characteristic Data (Reference)

* Characteristic data is not guaranteed value but measured values of samples from production line.

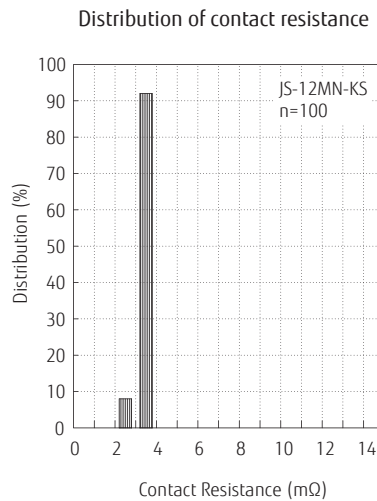
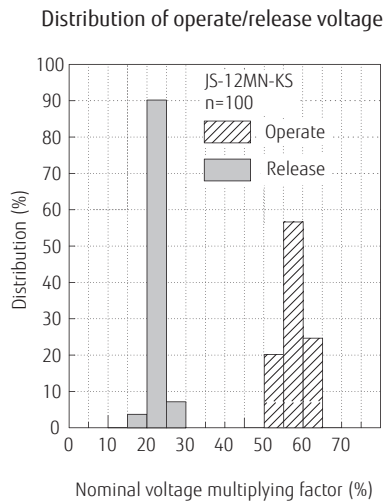
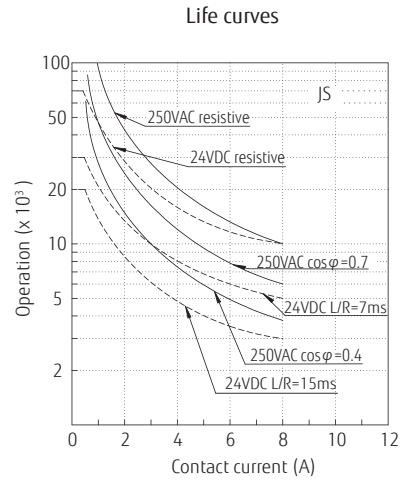
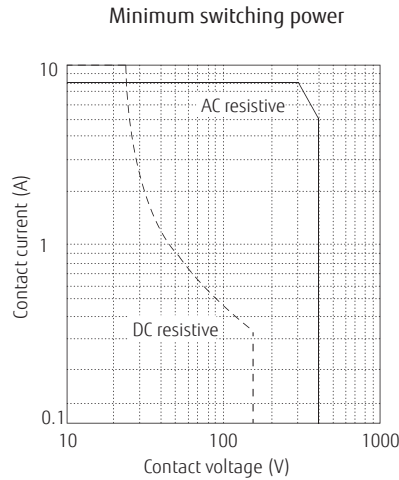
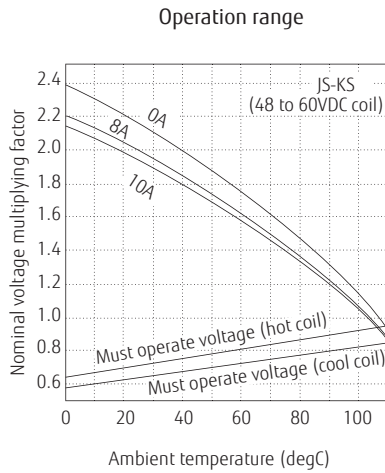
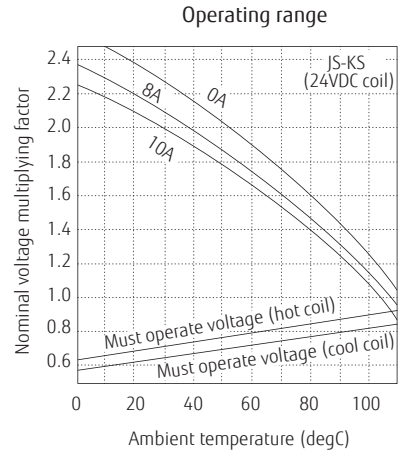
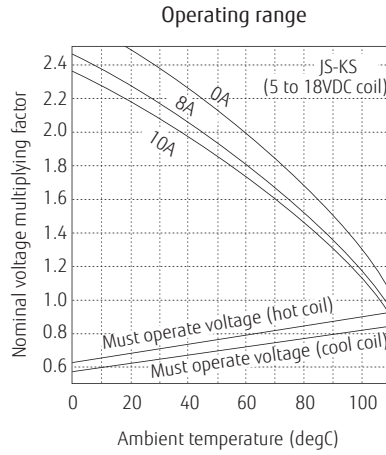
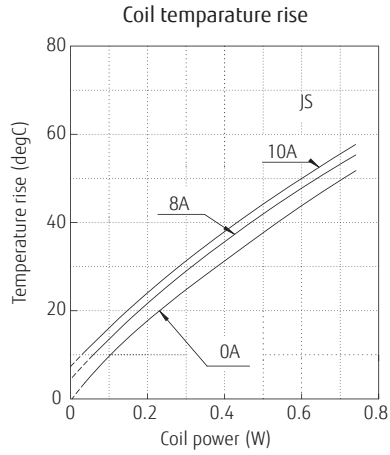

JS-KS Series

■ Dimensions

- Dimensions

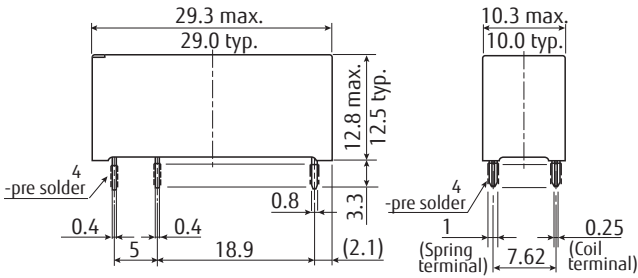

* Dimensions of the terminals do not include thickness of pre-solder.

- Schematics
(BOTTOM VIEW)

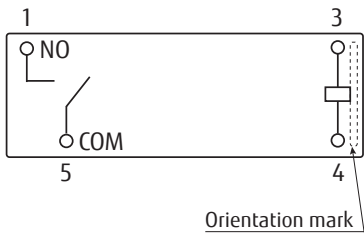

- PC Board Mounting Hole Layout
(BOTTOM VIEW)

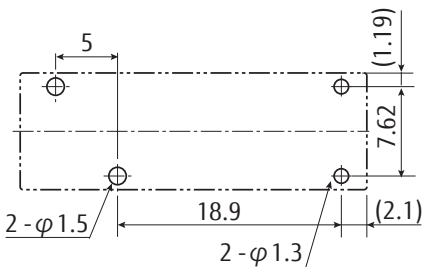

(): Reference value
Unit: mm

* Tolerance of PC board mounting hole layout : ±0.1 unless otherwise specified.

JS-KS Series

CAUTIONS

- All values mentioned in this datasheet are provided under ideal conditions. Please perform the confirmation test before actual use.
- Reflow soldering is prohibited.
- Do not use relays in the atmosphere with sulfide gas, chloride gas or nitric oxide. Contact resistance may increase.
- Do not use silicon or silicon-containing product or materials near relays. It may cause contact failure.

GENERAL INFORMATION

1. ROHS Compliance

- All relays produced by Fujitsu Components are compliant with RoHS directive 2011/65/EU, including commission delegated directive 2015/863.

2. Recommended lead free solder condition

- Lead free solder plating on relay terminals is Sn-3.0Ag-0.5Cu, unless otherwise specified. This material has been verified to be compatible with PbSn assembly process.
- Recommended solder for assembly: Sn-3.0Ag-0.5Cu.

Flow Solder Condition:

Pre-Heating: maximum 120°C
within 90 sec.

Soldering: dip within 5 sec. at 255°C±5°C solder bath

Relay must be cooled by air immediately after soldering

Solder by Soldering Iron:

Soldering Iron: 30-60W

Temperature: maximum 340-360°C

Duration: maximum 3 sec.

We highly recommend that you confirm your actual solder conditions

3. Moisture Sensitivity

- Moisture Sensitivity Level standard is not applicable to electromechanical relays, unless otherwise indicated.

4. Tin Whiskers

- Dipped SnAgCu solder is known as presenting a low risk to tin whisker development. No considerable length whisker was found by our in house test.

Fujitsu Components International Headquarter Offices

Japan FUJITSU COMPONENT LIMITED Shinagawa Seaside Park Tower 19F, 12-4, Higashi-shinagawa 4-chome, Shinagawa-ku, Tokyo, 140-0002, Japan Tel: (81-3) 3450-1682 Fax: (81-3) 3474-2385 Email: fcl-contact@cs.jp.fujitsu.com Web: www.fujitsu.com/jp/fcl/	Asia Pacific FUJITSU COMPONENTS ASIA, LTD. 102E Pasir Panjang Road #01-01 Citilink Warehouse Complex Singapore 118529 Tel: (65) 6375-8560 Fax: (65) 6273-3021 Email: fcal@sg.fujitsu.com Web: www.fujitsu.com/sg/products/devices/components	Korea FUJITSU COMPONENTS KOREA LIMITED Alpha Tower #403, 645 Sampoong-dong, Bundang-gu, Seongnam-si, Gyeonggi-do, 13524 Korea Tel: (82) 31-708-7108 Fax: (82) 31-709-7108 Email: fcal@sg.fujitsu.com www.fujitsu.com/sg/products/devices/components/
North and South America FUJITSU COMPONENTS AMERICA, INC 2290 North First Street, Suite 212 San Jose, CA 95131, USA Tel: (1-408) 745-4900 Fax: (1-408) 745-4970 Email: components@us.fujitsu.com Web: us.fujitsu.com/components	China FUJITSU ELECTRONIC COMPONENTS (SHANGHAI) CO., LTD. Unit 4306, InterContinental Center 100 Yu Tong Road, Shanghai 200070, China Tel: (86-21) 3253 0998 Fax: (86-21) 3253 0997 Email: fcal@sg.fujitsu.com Web: www.fujitsu.com/sg/products/devices/components	
Europe FUJITSU COMPONENTS EUROPE B.V. Diamantlaan 25 2132 WV Hoofddorp Netherlands Tel: (31-23) 5560910 Fax: (31-23) 5560950 Email: info@fceu.fujitsu.com Web: www.fujitsu.com/uk/components	Hong Kong FUJITSU COMPONENTS HONG KONG CO., LTD Unit 506, Inter-Continental Plaza No.94 Granville Road, Tsim Sha Tsui, Kowloon, Hong Kong Tel: (852) 2881-8495 Tex: (852) 2894-9512 Email: fcal@sg.fujitsu.com Web: www.fujitsu.com/sg/products/devices/components/	

©2020 Fujitsu Components Europe B.V. All rights reserved. All trademarks or registered trademarks are the property of their respective owners.

The contents, data and information in this datasheet are provided by Fujitsu Component Ltd. as a service only to its user and only for general information purposes.

The use of the contents, data and information provided in this datasheet is at the users' own risk.

Fujitsu has assembled this datasheet with care and will endeavor to keep the contents, data and information correct, accurate, comprehensive, complete and up to date.

Fujitsu Components Europe B.V. and affiliated companies do however not accept any responsibility or liability on their behalf, nor on behalf of its employees, for any loss or damage, direct, indirect or consequential, with respect to this datasheet, its contents, data, and information and related graphics and the correctness, reliability, accuracy, comprehensiveness, usefulness, availability and completeness thereof.

Nor do Fujitsu Components Europe B.V. and affiliated companies accept on their behalf, nor on behalf of its employees, any responsibility or liability for any representation or warrant of any kind, express or implied, including warranties of any kind for merchantability or fitness for particular use, with respect to these datasheets, its contents, data, information and related graphics and the correctness, reliability, accuracy, comprehensiveness, usefulness, availability and completeness thereof. Rev. September 25, 2020